

INSTALLATION AND OPERATION MANUAL

D11S – Surface Mount Digital Depth Sounder with Transom/Glue-In Transducer



To ensure safety and many years of trouble-free operation of your product, please read this manual carefully before using this product.

SAFETY INFORMATION:

- Periodically wipe the face with a dry cloth. Do not use abrasives or solvents on this device.
- Only qualified personnel should perform repairs or servicing not covered in this manual.
- The LCD used in the product is made of glass. Therefore, it can break when the product is dropped or impacted.
- Keep this product away from heat sources such as radiators, heaters, stoves and other heat generating sources. Do not store in extreme temperatures above 150° F (65° C).
- Shade the LCD during storage. Do not expose LCD to direct sunlight for extended periods of time.

NOTES, NOTICES, AND CAUTIONS



WARNING: Indicates a potential for property damage, personal injury or death.



IMPORTANT: Indicates potential damage to the device and tells you how to avoid it.



NOTICE: Indicates important information that helps you make better use of the device and tells you how to correct a performance problem.



INFORMATION: Indicates resources to obtain the proper information to help you make the most of your device.

INFORMATION:



Read this manual completely before attempting to use or install your device. Visit our Customer Service Center on our website for advanced troubleshooting and technical support.

WARNING:



This depth sounder should not be used as a navigational aid to prevent grounding, boat damage, or personal injury. Always operate the boat at slow speeds in unfamiliar water, or if you suspect shallow water or submerged objects.

PARTS SUPPLIED IN PACKAGING

The following parts should be included with the display:

- Micro Depth Sounder Display
- Digital Depth Sounder Module (DSM) with waterproof fuse housing and .25A, 250V fuse.
- Surface Mount Bracket
- (2) #2 x 3/8" Stainless Steel Screws
- Alarm Buzzer

The following parts should be included with the transducer:

- Transducer with 30' of Cable and Plug
- Transducer Support Bracket with Attached Kick-Up Bracket
- (2) Tapered Plastic Shims
- (2) Cable clamps
- Clam Shell Cable Cover
- (2) #10 x 1.25" self-tapping screws
- (4) #6 x 1/2" self-tapping screws

If any items are missing or damaged, please contact our customer service department.

SELECTING THE PROPER TRANSDUCER INSTALLATION

NOTICE:



The included transducer can be either Transom Mounted or glued in hull. We also offer the option to trade-in the standard transducer for a customized transducer. Please visit our website for details.

Transom mounting is suitable for the following vessels:

- Outboard, inboard/outboard, single inboard or jet-drive propulsion.
- Hull deadrise angle below 30°.
- Transom angle from 3-20°.

Glue-in mounting is suitable for the following vessels:

- High speed boats to increase the performance of the depth sounder.
- Trailer boats to prevent accidental damage to the transducer from trailering.
- Shallow draft boats to prevent accidental damage to the transducer from intentional or unintentional ground.

- NON-CORED hulls or aluminum hulls thinner than 1/8”.
- Inboard vessels that have a lot of running gear that creates significant turbulence.

NOTICE:



Glue-in mounting of the transducer is NOT suitable for all vessels. You MUST test the glue-in location on the water prior to using epoxy to permanently affix it to the hull. If you cannot obtain satisfactory readings during on water testing you will need to transom mount the transducer, or switch to a custom transducer.

If you think that the included transducer is not suitable for your installation visit our Customer Service Center at www.hawkeyelectronics.com to contact us or to complete a transducer exchange request to exchange the transducer for one that is specialized for your vessel. You may also call 888-766-7276 to inquire about exchanging the transducer.

INSTALLING THE DISPLAY

Tools & Supplies Required for Installation

- Power Drill
- 19/32” (15 mm) Drill Bit, Hole Saw, or Spade Bit (Warning Buzzer Installation)
- 1/2” (12 mm) Drill Bit, Hole Saw, or Spade Bit (LCD Display Plug Pass Through)
- 1/16” (2 mm) Drill Bit (LCD Display Mounting Screws)
- Wire Connectors Suitable for Connecting the Power Wire to Your Vessel
- Wire Cutting/Crimping Tool
- Zip-Ties
- Marine Sealant
- (4) Stainless Steel Screws or Bolts (DSM Mounting)
- Silicon Grease or Petroleum Jelly

WARNING:



Check behind the desired cutting area for wires, switches, etc. that may be damaged during cutting. If these obstructions are present, use masking tape to hold them out of the way during cutting.

STEP 1

Mark & Drill the Holes

1. Find a location on the vessel that will allow clear viewing of the display. Keep in mind that the wires for the DSM must reach the mounting location of the display.
2. Lay the Display Mounting Bracket against the mounting location and using a pencil, mark mounting holes (A, B).
3. Drill (2) 1/16" (2 mm) holes at location A.
4. Drill (1) 1/2" (12 MM) hole at location B.

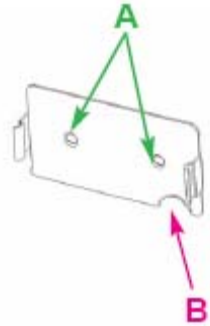

Install the Display

1. Insert the Display Cable (D) into the hole B.
2. Install and fasten the Display Mounting Bracket (C) by installing the supplied (2) #2 x 3/8" Stainless Steel Screws in the holes labeled A.
3. Feed the remaining Display Cable (D) through the Cable Pass Through (B).
4. Secure the Display Housing (E) to the Display Mounting Bracket (C) by aligning the Mounting Tabs (F) with the notches on the back of the Display and pressing securely together.

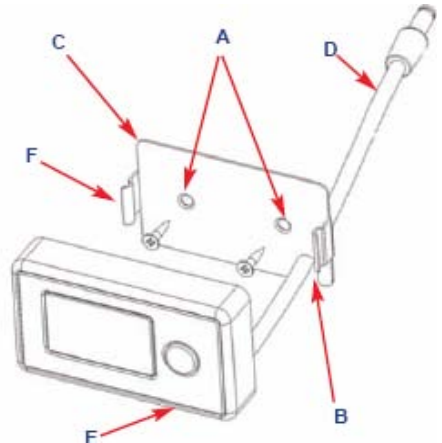

STEP 2

Installing the Digital Depth Sounder Module (DSM)

1. The mounting location for the DSM must not allow exposure to excessive heat or submersion in bilge water. Also, make certain that the cables for the Transducer and Display reach the desired mounting location.
2. There are several ways to mount the Electronics Housing. Be certain that the installation that you choose is secure and will not allow the housing to move around.



- A. Using a pencil, mark the mounting holes in the Housing. Check behind the desired mounting location for any cables or wiring that could be damaged during drilling. You will have to supply your own screws, so make certain that the length of screw that you have chosen will not penetrate an undesirable location (through the bottom, side, top, etc of the vessel). Drill and install screws through the Housing mounting holes into the drilled holes.
- B. Using an alcohol solution, clean both the DSM and the Mounting Location. Apply a marine grade adhesive or tape that is resistant to gas and oil, to the back of the housing and press it against the mounting location.
- C. Use Zip-Ties to secure the Housing to a solid surface.



STEP 3

Installing the Audible Alarm Assembly

NOTICE:



Make certain that the desired mounting location allows for access to the back of the Alarm Housing (A) when it is installed as you will have to install the Nut (B) from the back. Please keep in mind that the cable from the Alarm Housing to the electronics box must reach the desired mounting location.

1. Find a location on the vessel that will allow the audible alarm to be heard by the operator under ALL operating conditions. Mark that location with a pencil.
2. Check behind the desired mounting location for any cables or wiring that could be damaged during Installation and secure them out of the way.
3. Using the 19/32" (15 mm) drill bit, drill the hole for the Alarm Housing (A).
4. Remove the Nut (B) from the Alarm Housing (A) and Cable Assembly (C).
5. Seal any penetration into wood with a marine sealant.
6. Insert the Plug (C) through the hole you just drilled, and press the Alarm Housing into the hole until it is flush against the mounting surface.
7. Access the back of the Alarm Housing from below the mounting surface and install the Nut (B), turning clockwise until it is tight and the Alarm Housing does not rotate.

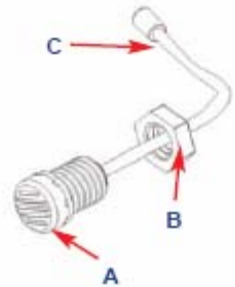

STEP 3

Linking the System Wires

12 Volt Power Harness: (A)

The system has an ON/OFF switch as well as an Auto Power-OFF feature. It is recommended that you connect the power harness to a constant power source such as a terminal block or directly to the battery.

1. Connect the BLACK wire on the DSM harness to a negative (-) terminal or suitable ground.
2. Connect the RED wire on the DSM harness to a positive (+) 12 Volt power source.

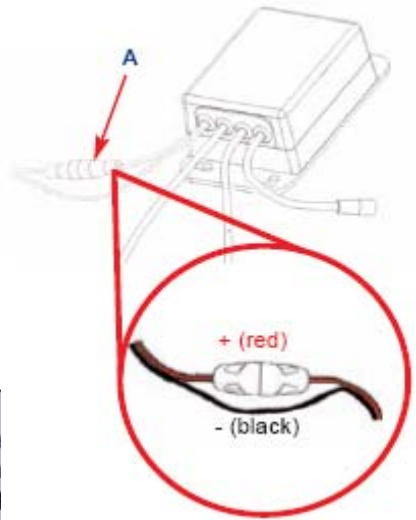

The Alarm System: (B)

1. For extended waterproofing of the connection, lubricate the plug by applying a generous amount of silicon grease or petroleum jelly to the ridge on plug B on the DSM.
2. Firmly press plug B into the Alarm Assembly's plug.

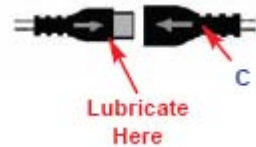
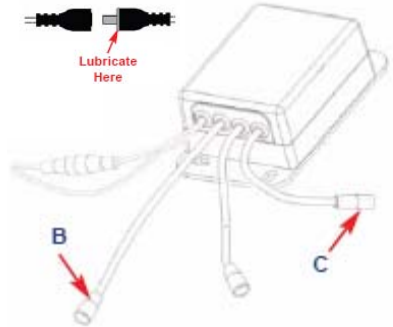

IMPORTANT:



BE VERY CAREFUL WHEN MAKING THE DISPLAY CONNECTION. Improper alignment of the plugs and internal pins will cause unrepairable damage to the connector.

The Display: (C)

1. Lubricate the plug by applying a generous amount of silicon grease or petroleum jelly to the Display Plug.
2. Align the arrows on the Display Plug and Plug C, and gently, but firmly press them together until the arrow on the display plug touches Plug C's housing.

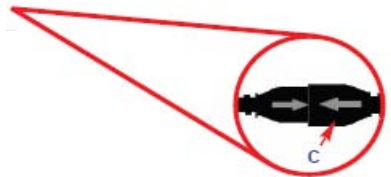

STEP 4

Testing the Display Installation

Before continuing with your installation, you should test the unit to make sure the system wires are properly attached.

1. Apply power to the unit by turning on the power source that you've attached the red and black wires to.
2. Press and release the button on the display.
3. The alarm should beep 3 times while the display illuminates all the LCD graphics for 2 seconds.
4. "----" will then be shown on the LCD.

If the display operates as per above, continue to the "Getting to Know Your Micro Depth Sounder" section.



If the display does not turn ON:

1. Check the power source using a test light or DC volt meter. Make sure there is 12 volt power where the power harness connects to both the positive and negative sources.
2. Check the fuse holder assembly with a test light or DC volt meter. Connect the ground to the test meter or light to the vessel's negative power source.
 - A. Remove the fuse and check for 12 volt power at the spring located inside the fuse housing that is connected to the vessel's power source. *If 12 volt power is present continue to Step 2-B. If power is not present, return to Step 1.*
 - B. Insert the fuse and check for 12 volt power at the end of the fuse. *If 12 volt power is present continue to Step 2-C. If power is not present, replace the fuse*
 - C. Reassemble the fuse housing. Strip back a quarter of an inch of wire cover on the display side of the fuse housing and test for 12 volt power. *If 12 volt power is present continue to #3 below. If power is not present, replace the fuse housing assembly.*

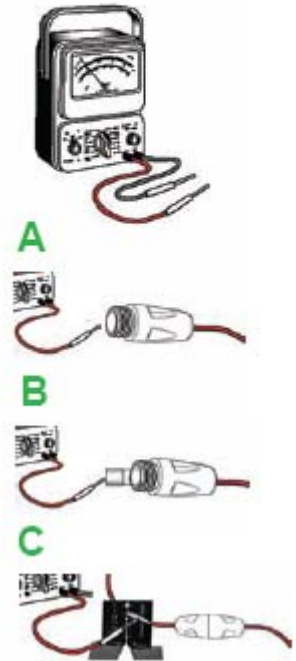

IMPORTANT:



The fuse used in the Micro Depth Sounder is a .25A, 250V fuse. Do not rely on a visual inspection of the fuse to determine if it is functioning. If your depth sounder will not turn on, ALWAYS test the fuse with a test light or voltage meter.

3. Check the Display Plug Pins

- a. Disconnect the display plug from the DSM.
- b. Look inside the end of the display plug. If the pins are bent, use a small screwdriver to straighten them.
- c. Reassemble making sure to properly align the arrows.

4. If you still can not get the system to turn on, visit our Customer Service Center on our website or call 888-766-7276 for advanced technical support.



GETTING TO KNOW YOUR MICRO DEPTH SOUNDER



The HawkEye® Micro Depth Sounder's auto-ranging, auto-sensitivity features mean that you never have to worry about adjustments. Simply turn the power on, and you're ready to go. The DSM emits sound signals that travel through water, and then calculates the amount of time that elapsed while the signal traveled down to the bottom and returned back to the transducer. This time is calculated by the DSM and

displayed as a depth reading on the LCD. Extremely dirty water, very soft bottom, high speeds, improper transducer mounting, deep water, or a combination of the above will result in incomplete or inaccurate readings. Under these conditions inaccurate readings or "---" will be displayed.

POWERING THE DISPLAY ON AND OFF

To Power ON - Press and release the button on the front of the Display. The LCD will display a test sequence and then switch to normal operation.

Manually Powering OFF - Press and HOLD the button for 5 Seconds. Release when "OFF" is displayed on the display. The unit is now OFF.

Auto OFF Feature - to help save your battery if you forget to turn the D11S OFF, the unit will automatically turn OFF if "---" is displayed on the LCD for 5 continuous minutes.

SETTING THE UNITS OF MEASURE

The units of measure for depth readout and alarm functions can be set in 4 easy steps. The two settings available are Feet (FT) and Meters (M).

To Set the Units:

1. Press and hold the button for 3 seconds until the units indicator (FT or M) blinks.
2. To set the units to FEET press the button. "FT" will flash on the Display.
3. To set the units to METERS press the button. "M" will flash on the Display.



4. The display will return to the normal operation mode automatically after five seconds.

SETTING THE DEPTH ALARM

The alarm function can be set for depths ranging from 2 to 10 feet and triggers an Audible and LCD Icon Alarm when the depth is less than the setting.

To set the SHALLOW ALARM:

1. Press and release the button located on the front of the D11S display. The current alarm setting will be displayed on the display. "0" is the default setting and will turn the alarm "OFF".
2. Pressing the key will increase the selected value. When the setting reaches "10", the next key pressed will reset the alarm to "0".
3. After your selection is made, the display will return to normal operation after 5 seconds.



NOTICE:



To turn the alarm OFF, the alarm should be set to "0".

When triggered, the audible alarm sounds for 10 seconds while the "🔔" icon flashes on the display. After 10 seconds, the audible alarm mutes and the "🔔" icon continues to blink until the depth increases or the alarm is reset. To reset the alarm repeat steps 1 thru 3.

TRANSOM MOUNTING THE TRANSDUCER

IMPORTANT:



Transom mounting the transducer is suitable for most vessels and generally offers the best performance. If you decide to glue the transducer in-hull, you **MUST** test the location on water prior to permanently affixing it to the hull.

If you cannot obtain satisfactory readings during on water testing you will need to transom mount the transducer, or switch to a custom transducer. If you have determined that you are going to try to glue the transducer in-hull, please skip to the next section.

STEP 1

Choosing a Mounting Location

To obtain the best performance, the transducer should be mounted in a location where the water flow beneath the hull is aeration and turbulence-free. Try to mount the transducer as close to the centerline of the boat as possible. Consult the boat manufacturer for the best in-hull transducer placement. If this information is unavailable, follow the guidelines below.

- A. On a single drive outboard or inboard/outboard boat, mount on the starboard side at least 4" beyond the radius of the propeller.
- B. On a twin outboard or inboard/outboard boat, mount between the drives, making certain that the transducer is not directly in front of either drive or propeller (avoid aligning directly in line with the bottom of the boat if the hull comes to a point).
- C. On an inboard boat, mount as far to the port or starboard as possible so that the propeller turbulence does not affect the performance of the sensor.
- D. On a single jet drive boat, mount on the starboard side at least 4" outside the intake grate.
- E. On twin jet drive boats, mount on the center line, between the intake grates (avoid aligning directly in line with the bottom of the boat if the hull comes to a point).
- F. On sailboats, mount on the starboard side at least 6" outside the keel.
- G. On pontoon boats and catamarans, mount on the starboard hull at least 2" outside the hull protector or centerline.
- H. On PWC's, mount on the starboard side, at least 2" outside the intake grate.

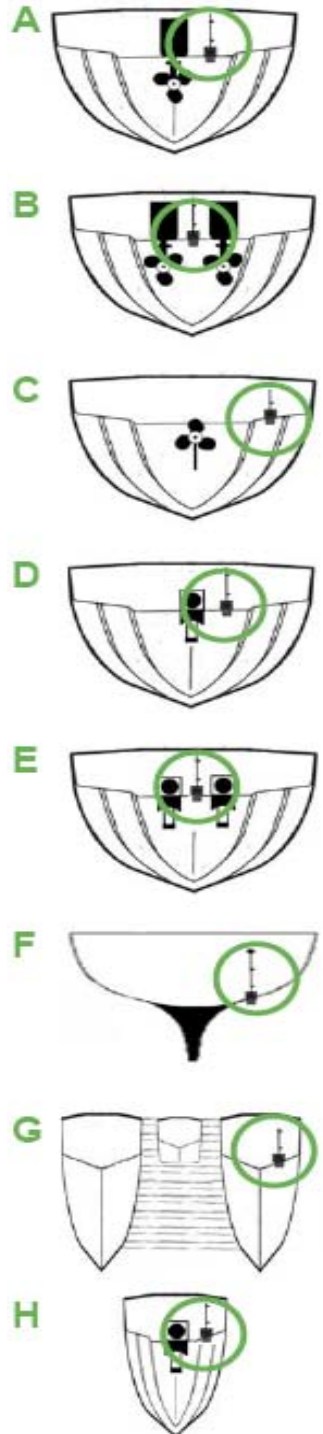

Mounting Location “DONT’S”

NOTICE:



To deliver consistent, accurate readings, the transducer must have a continuous supply of non-turbulent water. Do not mount the transducer in an area of turbulence or bubbles.

Never install the transducer where the boat may be supported during trailering, launching, hauling, or storage.

NEVER MOUNT:

- A. Behind water intakes, discharge openings, or thru-hull fittings.
- B. Behind strakes, struts, or hull irregularities.
- C. Behind transom steps or pockets.
- D. Behind eroding paint, hull deformities, or marine growth.
- E. Behind rivets or strakes on aluminum boats.
- F. Behind the step on stepped hulls.
- G. Directly on the “V” in the hull.
- H. Behind propellers or anywhere propeller turbulence will interrupt the flow of “clean” water to the transducer.
- I. In areas where the hull has a reverse angle.

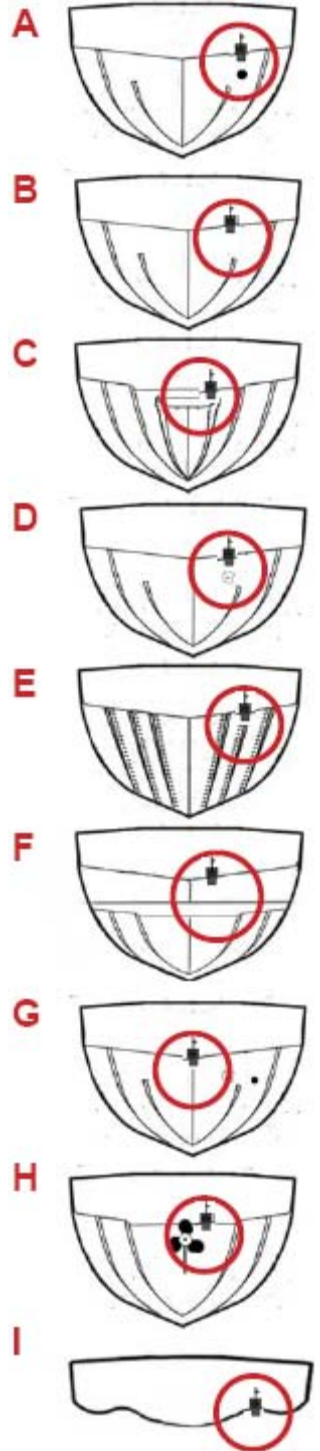

STEP 2

Assembling the Transom Mount Bracket

1. With the Locking Tab in the up position, align the transducer and bracket, then slide the transducer into the Pivot Bracket until it cannot slide any further (*minimal force is required*) (*illustration A*).
2. Press the Locking Tab down against the Pivot Bracket until it locks firmly into place.
3. Slide the Pivot Bracket arms through the back of Screw Bracket as pictured. (*illustration B*).
4. Grasp the transducer in your hand as shown in the picture to the right. Rest the screw bracket against a solid object (ground) and press the Pivot Bracket into the Screw Bracket with enough force until it snaps into place (*illustration C*).

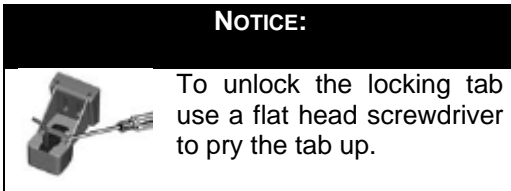
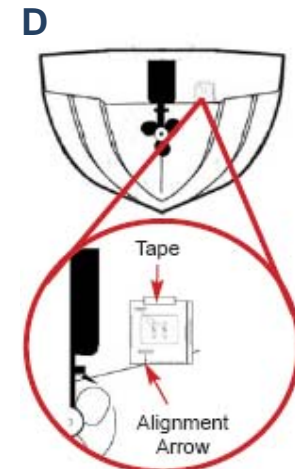
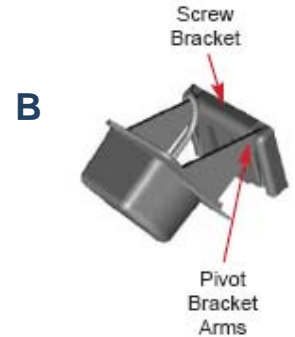
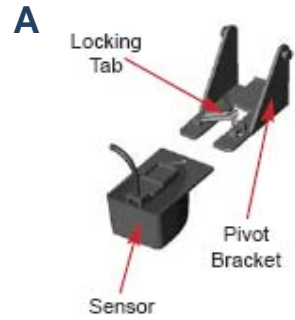

STEP 3

Mounting the Transom Mount Bracket

1. Locate Transom Template inserted in this manual.
2. At the desired mounting location, position the template so the arrow at the bottom is aligned with the bottom edge of the vessel making certain that the template is parallel to the waterline of the vessel.
3. Using a 9/64" (4 mm) drill bit, drill two holes 7/8" (22 mm) deep at the locations indicated on the template marked with an "X".

4. The bracket is designed for a standard 13° transom angle. To determine if the plastic shim is needed, position the transducer at the desired location. Using a straight edge, compare the underside of the transducer relative to the underside of the hull. The stern (trailing edge) of the transducer should be 1/16" - 1/8" (1 - 3 mm) below the bow (leading edge) of the sensor.



5. Apply a marine sealant to the threads of the two #10 x 1-1/4" self-tapping screws and screw the bracket to the hull. **DO NOT** tighten the screws completely until you position the transducer as per # 4 above.



NOTICE



Do not allow the leading edge of the transducer to extend more than 1/8"(3 mm) of an inch below the bottom of the boat as this will create increased aeration and turbulence.

NOTICE:



Align the included shims to achieve a slight angle as per the illustration below. To prevent aeration, **NEVER** position the transducer in a manner that the Leading Edge (*bow*) is **LOWER** than the Trailing Edge (*stern*).

CORRECT	I N C O R R E C T		
 Slight Angle	 Parallel	 Reversed Angle	 Too Steep of An Angle

STEP 4

Cable Routing

Route the transducer cable over the transom, through a deck or splash-well drain hole or through a new hole drilled in the transom. If a new hole is required, it **MUST** be drilled well above the waterline.

To Drill a Cable Pass Through:

1. Mark the desired location with a pencil.
2. Check for obstructions behind the desired location inside the hull.
3. Drill a 5/8" or 16 mm hole through the transom.
4. Route the cable through the transom.
5. On the outside of the hull, secure the cable against the transom using the included cable clamps. Evenly distribute the clamps between the transducer and the location where the cable passes through or over the hull and mark the location with a pencil.
6. At the marked locations, use a 1/8" (3 mm) bit to drill a hole 3/8" (10 mm) deep.
7. Apply marine sealant to the threads of the 2 #6 x 1/2" self-tapping screws, position the two cable clamps and fasten them in place (*illustration A*).

Skip to #12 if the cable was routed over the transom or a hole that was already in the hull.

8. If a hole has been drilled in the transom for the cable pass through, position the clam shell cover over the cable where it enters the hull and mark the two screw holes.
9. Use a 3 mm or 1/8" bit to drill a hole 10 mm (3/8") deep. To prevent drilling too deeply, wrap masking tape around the bit 10 mm (3/8") from the point of the bit.
10. Fill the remaining space in the hole with marine sealant (*illustration B*).
11. Apply marine sealant to the 2 #6 x 1/2" self-tapping screws and fasten the cable clam shell cover into place (*illustration C*).
12. Route the cable to the mounting location of the depth sounder transducer plug. To reduce electrical interference, separate the transducer cable from other electrical wiring. Coil any excess cable and secure it in place using tie wraps.
13. Lubricate the plug by applying a generous amount of silicon grease or petroleum jelly to the ridge on the Display plug (*illustration D*)
14. Plug the cable into the transducer plug on the depth sounder.



NOTICE



If you need to increase the length of the transducer cable order part # 8000-90 from our website or toll free at 888-766-7276. Strip back the rubber cable cover 1" (28 mm) exposing the three internal wires (blue, white, and bare) on your transducer. Using a soldering iron, solder the blue, white and bare wires from the 8000-90 extension cable to the corresponding wires on your transducer. Using electrical tape, or heat shrink tubing make certain that the soldered connections are completely sealed and protected against accidental electrical interference and corrosion. **Cutting the plug off the Digital Depth Sounder display will void the warranty.**

STEP 5

Antifouling Paint

Marine growth can accumulate rapidly on the transducer's surface. If the vessel is left in saltwater for extended periods of time, all components of the transducer below the waterline must be painted with WATER BASED antifouling paint.

- Never use ketone-based paint, as this type of paint can damage the transducer's plastic shell.
- Clear, spray-on antifouling paints are very easy to apply and can be purchased from your local boating supply store.
- Reapply paint as needed to prevent marine growth

STEP 6

Testing and Troubleshooting the Transom Mount Installation

1. Make sure that the display is functioning properly by following the display testing procedures in the Display Installation and Operation Manual.
2. Place the vessel in the water. Once the display is turned ON, it will display the test sequence and then display the current depth.
3. Become familiar with the depth sounder's function and performance at idle speeds.
4. Gradually increase the boat speed and observe the depth readings (*pay attention to minimum and maximum depth capabilities*).
5. If "---" readings appear:
 - Check to make sure that the transducer is not "kicked-up". To prevent damage to the transducer, it will automatically release from the mounting bracket (kick-up) when it is impacted. If this occurs, refer to Page 4 of this manual to reset the transducer for normal operation. If this happens frequently, make sure that the trailer or boat lift bunks do not interfere with the transducer during loading and unloading.

- Have someone run the boat on plane for you in smooth water. CAREFULLY look over the transom at the water flowing from the bottom of the boat over the base of the transducer. The water should be "Clean" with very little turbulence (air bubbles). If there are any air bubbles or turbulence seen passing underneath the transducer, move the transducer farther down on the transom bracket. If the performance does not improve, move the transducer to "Clean Water" making sure to fill any unused screw holes with marine sealant.

NOTICE



High Speed performance of the depth sounder may require extensive adjustment and testing to find the best transducer mounting location. This transducer has been tested to perform up to 60 MPH (97 KPH) in an In-Hull application. Not all boat hull configurations will allow for this type of performance. If you are not satisfied with the performance of the depth sounder, it is recommended that you seek the advice of a professional marine electronics installer.

GLUING THE TRANSDUCER IN-HULL

NOTICE:



Please use extreme caution when selecting your adhesive as the overall performance and enjoyment of your depth sounder depends heavily on the type of adhesive you use. **USE ONLY A 2-PART, SLOW CURE EPOXY**

Tools and Supplies Required

- Plastic Bag
- Petroleum Jelly
- 30 Grit Sandpaper
- 2 Part Epoxy Adhesive
- Tie Wraps

Vessel Hull Types Acceptable for In-Hull Installation

- High speed boats to increase the performance of the depth sounder.
- Trailer boats to prevent accidental damage to the transducer from trailering.
- Shallow draft boats to prevent accidental damage to the transducer from intentional or unintentional ground.
- **NON-CORED** hulls or aluminum hulls thinner than 1/8".
- Inboard vessels that have a lot of running gear that creates significant turbulence.

STEP 1

Choosing a Mounting Location

NOTICE:



If your hull is not SOLID fiberglass or up to 1/8th" Aluminum, this transducer CAN NOT be mounted in-hull. Refer to the Transom Mounting Instructions, visit our Customer Service Center on our website, or call 888-766-7276 to inquire about exchanging the transducer.

Since the hull absorbs acoustic energy, transmitting through the hull reduces the transducers performance. Fiberglass hulls are often reinforced in places for added strength. These cored areas contain wood or structural foam which are poor sound conductors. To achieve optimal performance, find a location where the hull's laminate is solid (not cored).

To obtain the best performance, the transducer should be mounted in a location where the water flow beneath the hull is aeration and turbulence-free. Try to mount the transducer as close to the centerline of the boat as possible. Consult the boat manufacturer for the best in-hull transducer placement. If this information is unavailable, follow the guidelines below.

- A. Outboard, Inboard/Outboard Powerboats - Install as close to the stern and centerline as possible.
- B. Inboard Powerboats - Install forward of the propeller(s), shaft(s), and running gear, as close to the centerline as possible. Keep in mind that many Ski Boats have fins that you need to avoid mounting near.
- C. Jet Boats - Install forward of the intake grate, as close to the centerline as possible.
- D. Stepped Hulls - Install forward of the step, as close to the centerline as possible.
- E. Sailboats - Install near the centerline of the hull and forward of the leading edge of the keel.
- F. Personal Watercraft (PWC) - Install forward of the intake grate, as close to the centerline as possible (*under the engine*).

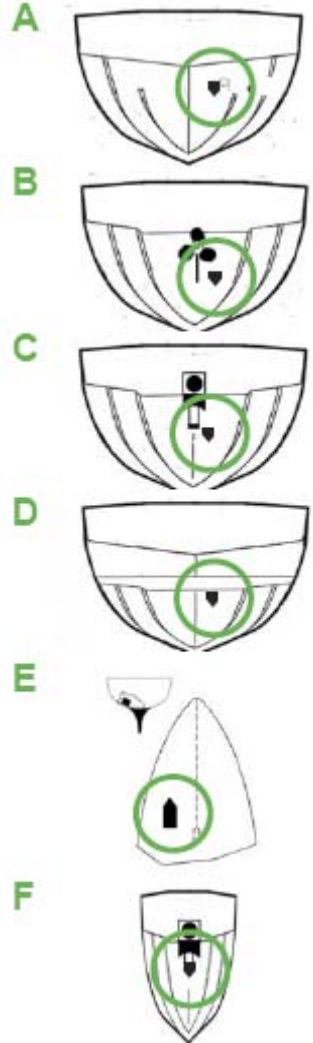

Mounting Location “DONT’S”

NOTICE:



To deliver consistent, accurate readings, the transducer must have a continuous supply of non-turbulent water. Do not mount the transducer in an area of turbulence or bubbles.

Never install the transducer where the boat may be supported during trailering, launching, hauling, or storage. Hull flexing may cause air pockets to form in the 2 Part Epoxy used to bond the transducer to the hull which over time will reduce the performance of the depth sounder.

WARNING:



Never install the transducer without testing the installation as per Step 2 below.

NEVER MOUNT:

- A. Behind water intakes, discharge openings or thru hull fittings.
- B. Behind strakes, struts, or hull irregularities.
- C. Behind transom steps or pockets.
- D. Behind eroding paint, hull deformities, or marine growth.
- E. Behind rivets or strakes on aluminum boats.
- F. Behind the step on stepped hulls.
- G. Directly on the “V” in the hull.
- H. Behind propellers or anywhere propeller turbulence will interrupt the flow of “clean” water to the transducer.
- I. In areas where the hull has a reverse angle.

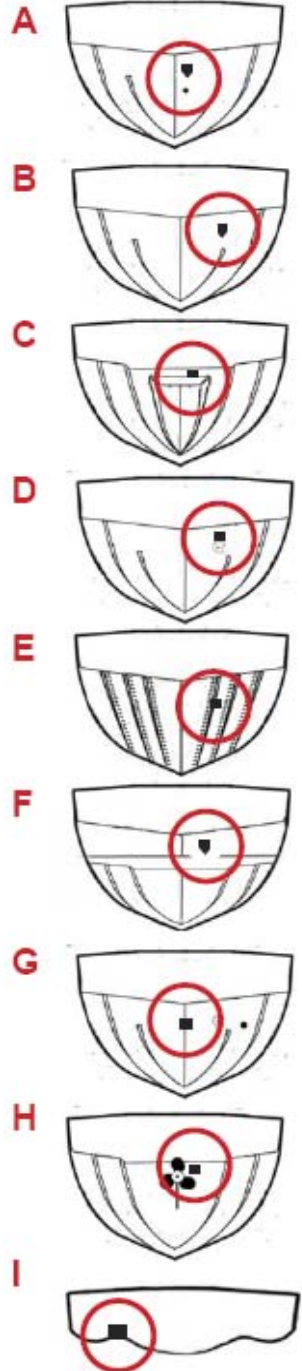

NOTICE:



To get a good “view” of the mounting location, while the vessel is out of the water, position yourself at the transom and look at the bottom of the hull towards the bow. Using illustrations A thru I, note anything that could interrupt the clean flow of water to the transducer mounting location.

STEP 2

Test the Selected Location

1. Anchor/Moor the vessel in a body of water away from other boat traffic.

NOTICE:



Turn OFF all other sonar devices on your boat and locate the vessel at least 50 feet from the nearest vessel.

2. Plug the transducer cable into the back of the depth sounder display and turn the display ON. Once the display is turned ON, it will display the test sequence and then display the current depth. Make sure the Keel Offset feature is turned OFF.
3. Place the transducer close to your ear (do not press up against your ear). If the transducer is properly connected it will be emitting a ticking sound (*similar to a wrist watch*). If you do not hear this ticking sound, recheck your connections or visit our Customer Service Center for advanced troubleshooting.
4. Hold the transducer over the side of the vessel so that it is the same distance below the water surface as it would be at the in-hull mounting location. Note the depth that is being displayed on the Depth Sounder.

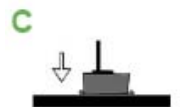
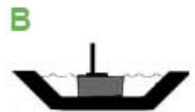
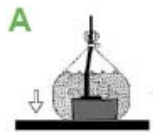

NOTICE:



Certain environmental conditions may restrict the performance of the depth sounder. Extremely dirty water, very soft bottom, high speeds, deep water, or a combination of the above will result in incomplete or inaccurate readings. If “--” appears on the display, relocate the vessel to cleaner water.

5. Remove the transducer from the water. Use one of the methods below to test the depth readings with the transducer at the desired in-hull location selected in Step 1.
 - A. If the hull surface is not smooth, sand it with 30 grit sandpaper until a smooth surface is obtained. Partially fill a thin plastic bag with water, place the transducer inside and close it tightly with a tie wrap. Wet the surface of the hull and press the transducer face against the hull through the bag. Proceed to # 6.
 - B. If the transducer will be located in an area in the hull that holds water, place the transducer against the hull and allow bilge water to cover the surface where the transducer touches the hull. Proceed to # 6.
 - C. If the hull surface is not smooth, sand it with 30 grit sandpaper until a smooth surface is obtained. Coat the face of the transducer with petroleum jelly and press it against the hull with a twisting motion. Use duct tape to hold it in place. Proceed to # 6.

NOTICE:



One of the easiest ways to temporarily secure the transducer in hull is by following 5-B and wrapping the cable around the transducer as pictured.

6. If “---” readings appear or the readings are noticeably different from the depth displayed when the transducer was hung over the side of the boat, you will need to find another location. If the readings are similar mark the spot in the hull and proceed to # 7.
7. Temporarily anchor the transducer on the marked spot using duct tape.
8. Remove the vessel from its mooring and operate it at idle speeds while getting to know the functions and performance of the depth sounder.
9. Gradually increase the boat speed and observe the depth readings (*make sure you stay in water between 2.5 and 200 feet deep*).
10. If “---” readings appear:
 - Put the vessel in a slow turn. If “---” disappears when turning, the transducer’s position probably needs adjustment because it is in aerated water.
 - If “---” does not disappear while turning, relocate the transducer using any one of the methods in # 5 and repeat #5 thru #10.
 - If following 5-B, make sure that your “---” readings are not caused by the bilge water flowing away from the transducer face while turning, accelerating or decelerating.

11. **DO NOT** proceed to the next step until you are satisfied with the readings. If you have difficulties please visit our Customer Service Center on our website or call 888- 667-2767 for technical assistance.

STEP 3

Gluing the Transducer In Place

APPROVED EPOXY	I N C O R R E C T
 <p data-bbox="82 662 295 716">2 Part, Slow Cure, Clear Epoxy</p>	 <p data-bbox="333 578 974 732">ANY ADHESIVE OR GLUE THAT IS NOT 2 PART, SLOW CURE EPOXY (<i>Silicon Sealant, Weather Sealants, "Rubbery" Caulks, Construction Adhesives, 5 Minute or Quick Cure Epoxies, Rubber Cements, Colored Epoxies, etc</i>)</p>

1. All surfaces to be bonded must be smooth, clean and dry. If the hull surface is not smooth, sand it with 30 grit sandpaper until a smooth surface is obtained in an area a little larger in diameter than the length of the transducer.
2. Clean and dry both the selected area and the face of the transducer with a weak solvent to remove any dust, grease or oil.
3. Prepare the adhesive as per the directions supplied with the adhesive (*DO NOT mix the epoxy on the transducer*).
4. Apply a generous amount of adhesive to the entire face of the transducer (side opposite from the cable) and the inside of the hull.
5. Press the transducer face onto the hull with a twisting motion to expel all air bubbles. (If the hull is slanted, temporarily secure the transducer in place with duct tape.)



Allow the adhesive to cure as per the manufacturer's instructions.

NOTICE:



Try to align the transducer so that the point is aimed at the bow of the vessel.

STEP 4

Routing the Cable

1. After the adhesive has cured, route the cable the mounting location of the depth sounder transducer plug. To reduce electrical interference, separate the transducer cable from other electrical wiring. Coil any excess cable and secure it in place using tie-wraps.
2. Plug the cable into the corresponding cable on the Digital Depth Sounder display.



STEP 5

Testing and Troubleshooting the Glue-In Installation

NOTICE:



High Speed performance of the depth sounder may require extensive adjustment and testing to find the best transducer mounting location. This transducer has been tested to perform up to 60 MPH (97 KPH) in an In-Hull application. Not all boat hull configurations will allow for this type of performance. If you are not satisfied with the performance of the depth sounder, it is recommended that you seek the advice of a professional marine electronics installer.

To Test Your Transducer Installation:

1. Make sure that the display is functioning properly by following the display testing procedures in the Display Installation and Operation Manual.
2. Place the vessel in the water. Once the display is turned ON, it will display the test sequence and then display the current depth.

NOTICE:



If “---” appears on the display, make sure that there is at least 2.5 feet of water between the bottom of the transducer and the bottom of the water body.

3. Become familiar with the depth sounders function and performance at idle speeds.
4. Gradually increase the boat speed and observe the depth readings (*pay attention to minimum and maximum depth capabilities*).
5. If you are not happy with the readings there are very little adjustments that you can do at this time. You will need to remove the transducer and return to Step 1 of the Glue-In Instructions.

NOTICE:



Certain environmental conditions may restrict the performance of the depth sounder. Extremely dirty water, very soft bottom, high speeds, deep water, or a combination of the above will result in incomplete or inaccurate readings. Please refer to Steps 1 & 2 of this section to minimize the effects of these conditions. If you are not happy with the performance of your depth sounder, please visit our website or call 888-766-7276 for technical support. Rest assured that this depth sounder is engineered to the highest standards and is part of the best selling family of depth sounders in the world. It is highly likely that your dissatisfaction is due to improper installation and/or setup, and our technical support resources can get your system working properly.

To Remove the Transducer:

1. Place a piece of wood against the base of the transducer.
2. Gently “TAP” the piece of wood with a hammer. DO NOT strike the transducer directly.
3. Once the transducer is removed from the hull, sand the excess epoxy adhesive off with sandpaper (*minor sandpaper scratches will not harm the transducer*). DO NOT use chemicals to remove the excess epoxy

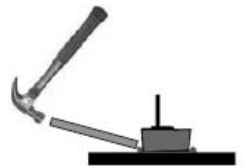

TROUBLESHOOTING AND FREQUENTLY ASKED QUESTIONS

24-Hour Technical Support is available online at hawkeyelectronics.com. Search our online Knowledgebase for the latest troubleshooting and FAQ's, or post your own question for our support staff. For one-on-one support please email customerservice@norcrossmarine.com.

INFORMATION:



If you have questions about this device please visit our Customer Service Center on our website or *call us toll free at 888-766-7276.*

Warranty Details • Warranty Registration
Troubleshooting • Product Knowledgebase
Product Specifications • Parts & Accessories
www.hawkeyelectronics.com

Sonar Cross Talk:

If you experience incorrect depth readings on your Digital Depth Sounder display, but nothing on another fish finder screen on the same boat (or vice versa) then you are experiencing sonar cross-talk interference. The only real solution is to move the transducers further away from each other. This can help keep the transducer cones from intersecting, but because cones get wider as the depth increases, the problem can not usually be completely solved by position only. Changing one of the sounders to another model that runs on a different frequency will solve the problem.

Using A Non-Standard Transducer:

You may be able to use a transducer that is currently installed in your watercraft or a specialized transducer. You need to be sure that the transducer runs on 200Khz and is able to put out 250 watts of transmitting power. If you are unsure of the specifications please contact the manufacturer. If you need to attach a non-standard transducer to the Digital Depth Sounder display, order part # 8000-90 from our website or toll free at 888-766-7276. Strip back the rubber cable cover 1" (28 mm) exposing the three internal wires (blue, black, and bare) on your transducer. Using a soldering iron, solder the blue, black and bare wires from the 8000-90 extension cable to the corresponding wires on your transducer. Using electrical tape, or heat shrink tubing make certain that the soldered connections are completely sealed and protected against accidental electrical

interference and corrosion. Cutting the plug off the Digital Depth Sounder display will void the warranty.

Poor Performance:

If you are not happy with the performance of your depth sounder, please visit our website or call 888-766-7276 for technical support. Rest assured that this depth sounder is engineered to the highest standards and is part of the best selling family of depth sounders in the world. It is highly likely that your dissatisfaction is due to improper installation and/or setup and our technical support resources can get your system working properly.

REPLACEMENT PARTS

Individual components are not available for sale on our website. If you need replacement parts, please email our customer service department.

ONLINE CUSTOMER SERVICE CENTER TOOLS

>> NORCROSS FREEDOM CLUB

**Discounts,
Giveaways,
Beta Testing,
more....**



It's Free. Join Today!

**Protect against
accidents and failures**

Coverage Details ▶

SQUARETRADE WARRANTY AVAILABLE

- Years of coverage
- Accidental Protection optional
- 5 day service Guarantee
- Fix or refund full purchase price
- 30%-50% off retailer prices

>> INTERACTIVE FISHING FORUM

FishingTells.com



Your Source For Everything Fishing!!!

WARRANTY

This device is covered by a 2 Year Limited Warranty. To be eligible for warranty coverage, you must register your product within 15 days of purchase. Visit our website for warranty details and to register.

- To Activate Your Warranty:
- Read and print out a copy of the warranty details for your records.
- Complete the registration form our website.
- Make a copy of your original purchase receipt and staple it to this manual. *You will need to present it in the rare occurrence that you need to send your product in for service.*
- Complete the information below and store this manual in a safe place. *You can print additional copies of this manual from our website.*

INFORMATION:



To aid in maintenance and service, record the following:

Date of Purchase: _____

Place of Purchase: _____

Date of Online Warranty Registration: _____

Production Date Code : _____ (3 digit code located on the DSM housing)

LEGAL

INFORMATION:



Made in China. Tested to comply with FCC, CE & ROHS standards if applicable. Visit our website for compliance and warranty information. All Specifications and Prices Subject to Change Without Notice.

NorCross Marine Products, Inc
(P) 888-7NorCross (888-766-7276),
(F) 407-370-6880,
(E) customerservice@norcrossmarine.com
(I) www.hawkeyelectronics.com

WARNING:



© 2008 NorCross Marine Products Inc., All Rights Reserved. ALL unauthorized copying of the content of this document without the expressed written consent of NorCross Marine Products, Inc is strictly forbidden.

NOTES